

# Signet 2724-2726 Series DryLoc pH and ORP Electrodes



3-2724.090 Rev. E 10/11 English



1. Use appropriate eye, face, hand, body and/or respiratory protection when using chemicals or solvents.
  2. Prior to installation or removal:
    - Depressurize and vent system
    - Drain below sensor level.
  3. Confirm chemical compatibility before use.
  4. Do not exceed the maximum temperature/pressure specifications.
  5. Do not alter product construction.
- If installing into a threaded connection:**
6. Inspect threads to ensure integrity. Do not install a sensor that has damaged threads.
  7. Apply PTFE tape to the process connection threads in accordance with industry practices.
  8. Hand tighten the sensor into the process connection. **DO NOT USE TOOLS.**

## CAUTION



**Do not use tools!  
Hand-tighten only.**

## 1. Description

The Signet 2724-2726 Series of pH and ORP electrodes is designed to minimize maintenance time and maximize value.

- The unique DryLoc® connector provides quick assembly and a secure connection featuring gold-plated contacts and an O-ring seal.
- The patented design features a lengthened reference chamber pathway to extend the operational life of the electrode.
- Wetted materials are selected to withstand a wide array of industrial applications.
- Multiple mounting features address the need for installation flexibility. These electrodes can be threaded into ¼ in. NPT or ISO 7/1 R¾ inch pipe fittings, submerged in a tank, or mounted into familiar Signet installation fittings.
- To build a stand-alone, self-contained pH control system, combine the electrode with a 2760 pH Preamplifier and add a 5700 pH/ORP Monitor or an 8750 pH/ORP Transmitter to move your control capability to the next level.
- Combine the electrode with the 2750 pH Sensor Electronics to provide a 4 to 20 mA loop to a Programmable Logic Controller (PLC), SCADA system, or datalogger.
- For more flexibility and unique features, pair the 2724-2726 series with a 2750 pH/ORP Sensor Electronics and the new 9900 Transmitter.
- Finally, connect up to six pH signals to one 8900 Multi-Parameter Controller with six 2750 pH/ORP Sensor Electronics using digital (S<sup>3</sup>L) serial data output for a truly amazing set of features, options and measurements.

### 1.1 Specifications

#### General

- Compatibility: 2750 Electronics, 2760 Preamplifier
- Shipping Weight: 0.25 kg (0.55 lb)
- pH Temp Sensor:
  - PT1000 versions are compatible with Signet 2750 pH/ORP Sensor electronics for connection to a PLC, to the Signet 8900 Multi-Parameter Controller or to the new Signet 9900 Transmitter.
  - 3 KΩ Balco versions are compatible with the Signet 2760 pH/ORP preamplifier for connection to the Signet 5700 pH/ORP Monitor and the Signet 8750 pH/ORP Transmitter.
- Process connection: ¼ in. NPT or ISO 7/1 R¾ threads or Signet flow fittings

#### Wetted Materials

- pH: PPS, glass, UHMW PE, FPM
- ORP: PPS, glass, UHMW PE, FPM, Platinum

#### Performance

- Efficiency: >97% @ 25 °C (77 °F)  
Efficiency indicates the "wellness" of a new electrode. Efficiency is measured by comparing the actual slope (mV/pH) at 25 °C to the theoretical output of 59.16 mV/pH. An efficiency of 97% to 100% is equivalent to a slope of 57.39 to 59.16 mV/pH.
- Measuring range:
  - pH: 0 to 14
  - ORP: ±2000 mV3-2726-LC: Low Conductivity fluids (20 to 100 µS/cm). ≤ 20 µS/cm, flow must be less than 150 ml/min. in a properly grounded system.  
3-2726-HF: For applications where hydrofluoric acid, in concentrations of 2% or less, will attack standard pH glass in levels of pH 6 and below, or in situations where process upsets may temporarily drop to these pH levels.

#### Standards and Approvals:

- Manufactured under ISO 9001 and ISO 14001
-  China RoHS (Go to [www.gfsignet.com](http://www.gfsignet.com) for details)

#### Recommended storage temperature:

- The best storage temperature for the 272X pH and ORP electrodes is 0 to 50 °C (32 to 122 °F)
- The electrode glass will shatter if shipped or stored at temperatures below 0 °C (32 °F).
- The performance life of the electrode will be shortened if stored at temperatures above 50 °C (122 °F)



## 1.2 Dimensions

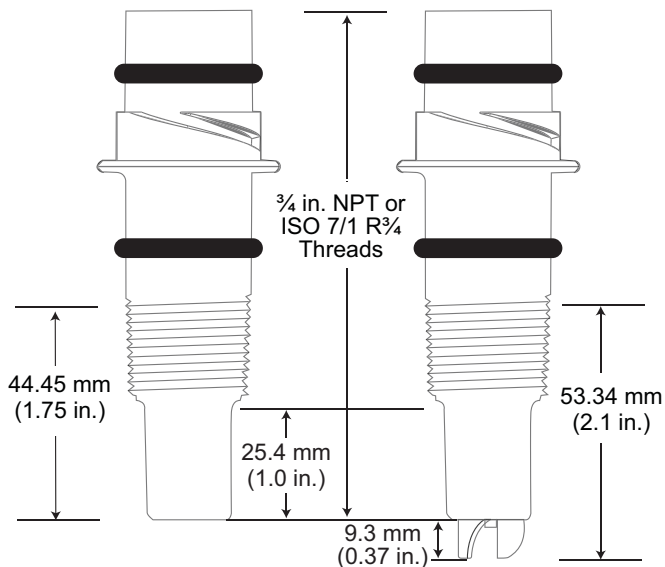

**⚠ Chemical Compatibility Warning**  
 The retaining nuts of pH and ORP sensors are not designed for prolonged contact with aggressive substances. Strong acids, caustic substances and solvents or their vapor may lead to failure of the retaining nut, ejection of the sensor and loss of the process fluid with possibly serious consequences, such as damage to equipment and serious personal injury. Retaining nuts that may have been in contact with such substances, e.g. due to leakage or spilling, must be replaced.

## 2. In-Line Installations

### 2.1 In-Line Installation Tips:

- Use the 1/4 in. threads on the electrode body to install the electrode into reducing tee fittings. The fitting must place the electrode in the flow but must not bottom out in the pipe.
- The electrode can be mounted at any angle. Avoid air pockets and sediment.
- Select a Signet installation fitting for convenience.
- Inspect threads to ensure integrity. Do not install an electrode with damaged threads.
- Use piping installation hardware with smooth, well-finished threads to facilitate the installation.
- Apply PTFE tape to the process connection threads, in accordance with industry standards.
- If necessary, the pipe should be plumbed with a depression (trap) so liquid is maintained around the electrode tip.
- Hand-tighten the electrode into the process connection. Do not use any tools to install the electrode. The use of wrenches, pliers or similar may over-stress the sensor body and lead to breakage and subsequent spillage of the process liquid. **CAUTION:** A broken sensor may be ejected forcefully from the fitting and can cause severe injury.
- The safety instructions have an adhesive label that should be placed near the sensor.

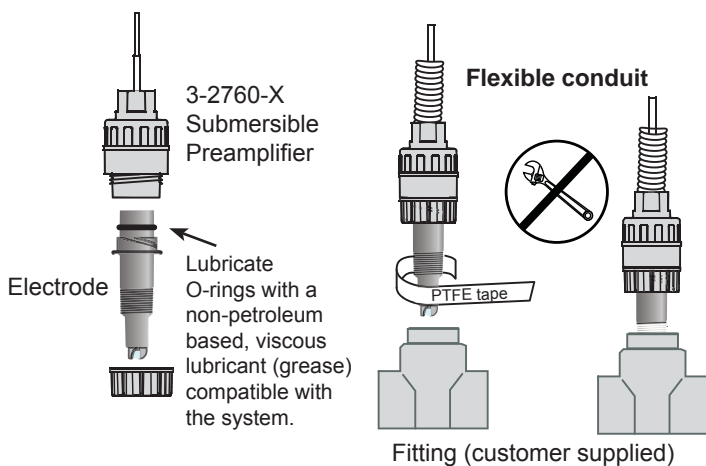

## 1.3 Operating Temperature and Pressure Specifications

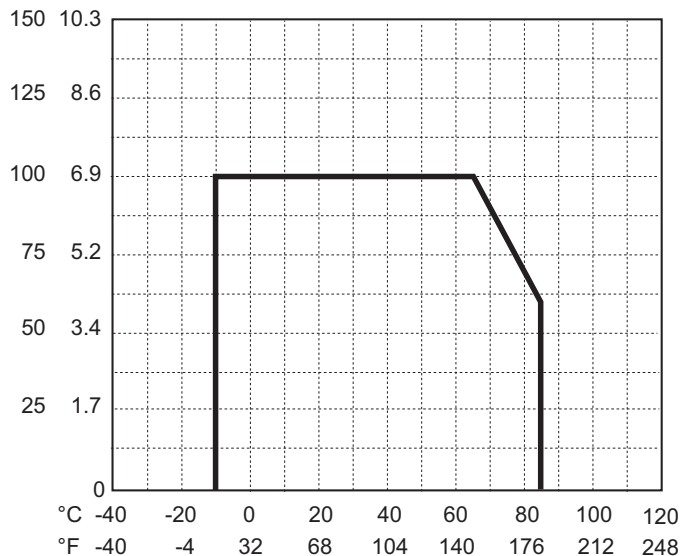

### Max. Temperature/Pressure Rating

Operating Temperature Range\*:  
 -10 to 85 °C (14 to 185 °F)  
 Operating Pressure Range:  
 -10 to 65 °C (14 to 149 °F),  
 0 to 6.9 bar (0 to 100 psi)  
 65 to 85 °C (149 to 185 °F),  
 linearity derated 6.9 to 4.0 bar (100 to 58 psi)



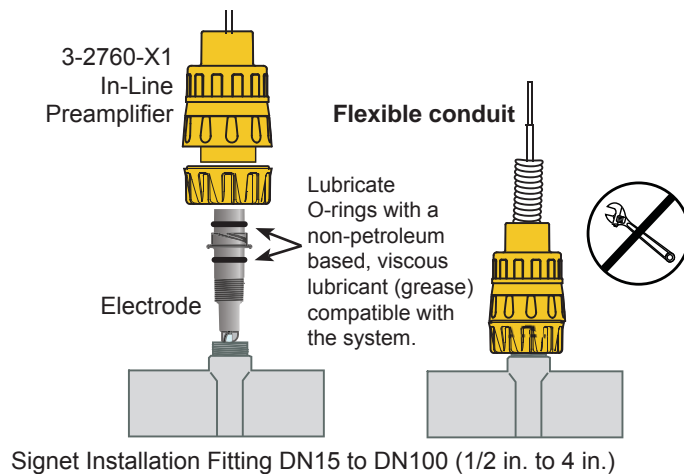
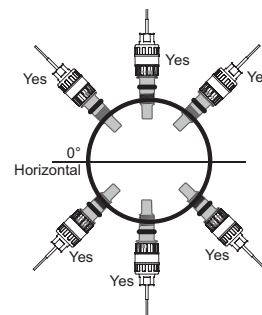



\*Best performance for 3-2726-HF-XX sensors is above 10 °C (50 °F)



## 2.2 Low Conductivity Installations

- The 3-2726-LC pH electrodes can be used in low conductivity water of less than 100  $\mu\text{S}$ .
- When used in the range of 20 to 100  $\mu\text{S}$ , the flow range must not exceed 1 m/s (3 ft/s) velocity.
- When used in liquids of less than 20  $\mu\text{S}$ , the flow range must not exceed 150 ml/min; the sensor should also be mounted in a well grounded cell.

## 2.3 Signet Installation Fittings

Type	Description	Type	Description
 Plastic tees	<ul style="list-style-type: none"> <li>• Available in 1/2 in. to 4 in. sizes</li> <li>• PVC, CPVC w/solvent cement socket</li> <li>• PVDF and PP w/union end fittings</li> </ul>	 Carbon steel weldolets	<ul style="list-style-type: none"> <li>• Available in 2 in. to 4 in. sizes</li> <li>• Requires 1-7/16 in. hole in pipe</li> <li>• Install by certified welder only</li> </ul>
 PVC saddles	<ul style="list-style-type: none"> <li>• Available in 2 in. to 4 in. sizes</li> <li>• Requires 1-7/16 in. hole in pipe</li> </ul>	 Carbon steel threaded tees	<ul style="list-style-type: none"> <li>• Available in 1/2 in. to 2 in. sizes</li> <li>• Female NPT ends</li> </ul>
 Iron strap-on saddles	<ul style="list-style-type: none"> <li>• Available in 2 in. to 4 in. sizes</li> <li>• Requires 1-7/16 in. hole in pipe</li> </ul>	 Universal pipe adapters	<ul style="list-style-type: none"> <li>• Use for installation in pipes &gt;4 in. (1 1/4 in. NPT)</li> <li>• PVC, CPVC, or PVDF versions</li> <li>• Specify socket or 1/4 inch NPT male threads</li> </ul>



**WARNING**

**SAFETY INSTRUCTIONS**

1. Use appropriate eye, face, hand, body and/or respiratory protection when using chemicals or solvents
2. Prior to installation or removal:
  - a. Depressurize and vent system
  - b. Drain below sensor level
3. Confirm chemical compatibility before use
4. Do not exceed the maximum temperature/pressure specifications
5. Do not alter product construction

If installing into a threaded connection:

6. Inspect threads to ensure integrity. Do not install a sensor that has damaged threads
7. Apply PTFE tape to the process connection threads in accordance with industry practices
8. Hand tighten the sensor into the process connection. **DO NOT USE TOOLS**

Failure to follow these instructions may result in personal injury

**Do not use as a handle!**

- Do not use tools or lubricant to install yellow retaining cap.
- Do not overtighten.

Lubricate O-rings with a non-petroleum based, viscous lubricant (grease) compatible with the system.

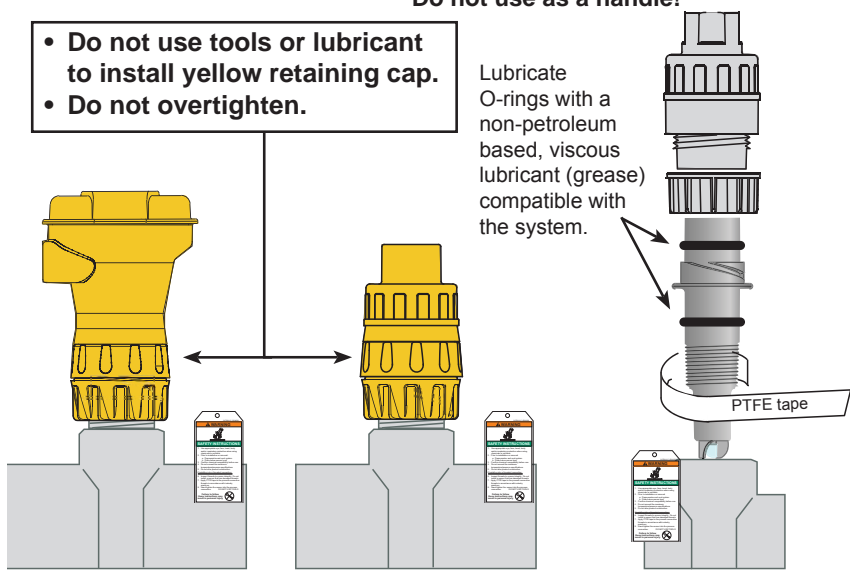

## 2.4 Removing the Electrode from In-Line Installations



The use of this product assumes that operators are trained and are familiar with this type of device. They should be knowledgeable of the potential risks associated with pressurized piping systems. Operators **MUST** follow all necessary safety procedures.

### In-line removal Instructions:

1. Depressurize and vent the piping system.
2. Drain the system to below sensor level.
3. Wear safety goggles or face shield during removal.  
Use all appropriate eye, face, hand, body and/or respiratory protection when working with chemicals or solvents.
4. Place a Lockout tag on the pipe when the sensor is removed for maintenance to prevent accidental opening and exposure to potentially hazardous chemicals.

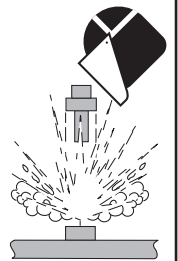

### 3. Submersible Installations

#### 3.1 Submersible Installation Tips:

- Choose a location that keeps the electrode glass completely submerged at all times.
- Mount electrodes in a location with ample clearance for removal.
- Mount the electrode near tank outlets, away from reagent addition areas.
- Use the 3/4 in. threads at the top of the preamplifier to run the cable inside pipe or conduit.
- Backfill a few inches of the conduit with sealant to prevent moisture intrusion from inside the conduit.
- Place the electrode tip in pH 4 buffer during system maintenance or storage to avoid dehydration.

#### 3.2 Submersible Installation, 2724-2726 with 2750/2760 Preamplifier

The Signet 2724 and 2726 pH electrodes are designed to install in tanks by attaching conduit to the 3/4 in. threads at the top of the accompanying preamplifier or sensor electronics:

1. The O-ring at the top of the electrode fits very tightly into the preamplifier. Use a small amount of non-petroleum based lubricant to assist the assembly.
2. To prevent moisture from migrating into the preamplifier, backfill the conduit with 3-4 inches of sealant.
3. Mount electrodes in a location with ample clearance to remove them for periodic cleaning and recalibration.
4. Choose a location that keeps the electrode glass completely submerged at all times.
5. The user must supply the following hardware to complete a submersible installation:
  - 3/4 in. NPT threaded pipe or conduit
  - Wiring junction box
  - Pipe clamps (quick-release type recommended)
  - Tank flange for closed tanks

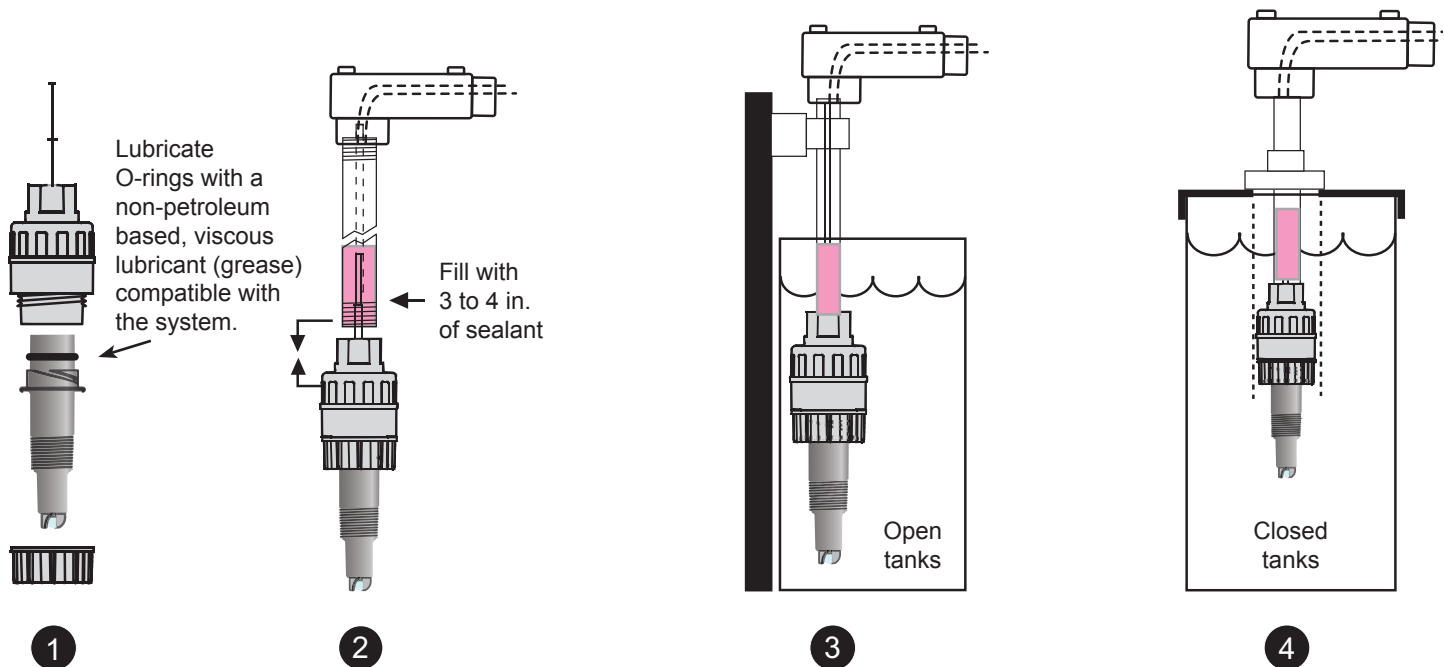

## 4. pH System Calibration

There are two functions in a pH electrode that require the system to be calibrated:

### 4.1 Temperature

- The temperature output of the electrode (from a 3K Balco or PT1000 RTD) must be calibrated only once, when a new electrode is installed. It does not need to be repeated.
- Because the temperature measurement has a significant influence on the electrochemical measurement, the temperature output in new pH electrodes should always be calibrated before the pH/mV calibration.

**NOTE:** All Signet transmitters and controllers incorporate automatic temperature compensation.

pH error due to temperature changes in fluid											
°C	pH 2	pH 3	pH 4	pH 5	pH 6	pH 7	pH 8	pH 9	pH 10	pH 11	pH 12
15	0.15	0.12	0.09	<b>**0.06</b>	0.03	0	0.03	0.06	0.09	0.12	0.15
25	0	0	0	* 0	0	0	0	0	0	0	0
35	0.15	0.12	0.09	0.06	0.03	0	0.03	0.06	0.09	0.12	0.15
45	0.3	0.24	0.18	0.12	0.06	0	0.06	0.12	0.18	0.24	0.3
55	0.45	0.36	0.27	0.18	0.09	0	0.09	0.18	0.27	0.36	0.45

**Table 1:**  
As the pH value moves away from neutral (7 pH) or the temperature moves away from 25 °C, the electrochemical output is affected.  
\* Example: At pH 5 the mV output of the electrode is not affected if the temperature is at 25 °C.  
\*\* The electrode output will be shifted by 0.06 pH units if the temperature is reduced to 15 °C.

### 4.2 Electrochemical pH vs. mV Ratio

- The mV output from the electrode is created by the interaction of the electrode and the fluid. The electrode contains a gel that depletes over time, so the instrument must be readjusted periodically to maintain system accuracy. The need for recalibration varies with each application, but the life of the electrode is usually consistent.
- Keep a maintenance log to establish a depletion trend in new systems.
- The mV calibration is a two-point procedure. Signet offers pH buffer solutions prepared specifically for this purpose.
- pH buffer solutions can be used for calibrating more than one sensor within a day provided that the solutions are protected from debris and are not diluted by rinse water from the calibration procedure.
- Use clean water to rinse buffer solutions from the electrode.
- Dispose of all buffer solutions at the end of the day.
- If the pH sensor will not calibrate within acceptable limits, clean the electrode and recalibrate. If the calibration results remain outside of acceptable limits, the sensor is depleted and must be replaced.
- Follow the guidelines of local waste disposal regulations when discarding buffer solutions and spent electrodes.

Theoretical mV Values @ 25 °C	
pH	mV
2	+295.8 mV
3	+236.64 mV
4	+177.48 mV
5	+118.32 mV
6	+59.16 mV
7	0 mV
8	-59.16 mV
9	-118.32 mV
10	-177.48 mV
11	-236.64 mV
12	-295.8 mV

**Table 2:**

Electrode slope is the ratio of mV to pH units. At 25 °C the theoretical slope is 59.16 mV per pH.

## 5. ORP System Calibration

ORP electrodes do not incorporate a temperature sensor, so the only system calibration required is the electrochemical adjustment.

### 5.1 Electrochemical ORP vs. mV Ratio

- ORP measurements are relative values, and single-point adjustments are sufficient for most applications.
- Calibration should be done using ORP test solutions such as Zobell's solution, Light's solution, or in pH buffers that have been saturated with quinhydrone (Table 3). Quinhydrone is the oxidizer that is measured by the ORP electrode.
- Zobell's solution and Light's solution are not compatible with the AutoCal function in Signet pH instrumentation.
- A new ORP electrode measures the listed values  $\pm 15$  mV.
- The ORP electrode is functional until the offset exceeds 50 mV.
- An electrode whose offset measures greater than 50 mV should be cleaned and replaced if necessary.
- ORP solutions made with quinhydrone are very unstable and may not read properly after being exposed to air for a prolonged time. These solutions must be discarded after a few hours.
- Dispose of all calibration solutions in accordance with local, state and federal guidelines.
- Use clean water to rinse buffer solutions from the sensors.

	Zobell's solution	Light's solution	4 pH buffer w/quinhydrone*	7 pH buffer w/quinhydrone*
ORP at 20 °C			268 mV	92 mV
ORP at 25 °C	228 mV	469 mV	263 mV	86 mV
ORP at 30 °C			258 mV	79 mV

**Table 3:**  
ORP test solutions

\*Saturate 50 mL of pH 4 or pH 7 buffer with 1/8 g quinhydrone

## 6. Electrode Date Code

The electrode date code indicates the manufacturing date of the electrode. Electrodes should be put into service as soon as possible and should not remain in the box for more than two years. Over time, the storage solution (found in the "boot" covering the electrode tip) will evaporate or leak, allowing the delicate sensing tip and reference junction to dry.

To rehydrate a dry electrode, soak it in pH 4 buffer for 24 to 48 hours. Electrodes more than 2 years old may still be functional, but will take longer to rehydrate. Restoration may not be effective for severely dehydrated electrodes.

First Letter = Month
N = January
M = February
L = March
K = April
J = May
H = June
G = July
F = August
E = September
D = October
C = November
B = December

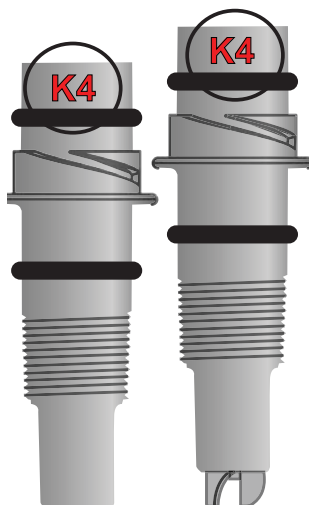

Second Numeral = Year
3 = 2008
4 = 2009
5 = 2010
6 = 2011
7 = 2012
8 = 2013
9 = 2014
0 = 2015
1 = 2016
2 = 2017
3 = 2018
4 = 2019

Example: K4 = manufactured in April 2009

## 7. Maintenance and Cleaning

### 7.1 Electrode Care and Application

pH/ORP electrodes are similar to batteries; they age with time and usage. The following information will help maximize electrode life.

#### General Tips:

- To ensure uninterrupted operation of critical pH systems, replacement electrodes should be available.
- Store boxed electrodes flat or upright (electrode tip down) to maximize hydration of the glass surface.
- Keep the glass surface wet at all times.
- Soak the sensor tip in pH 4.0 buffer during system maintenance intervals.
- If the sensor dehydrates, soak the sensor tip in pH 4 buffer for 24 to 48 hours, then visually inspect the electrode for surface cracks, swelling, or discoloration.
- It may not be possible to restore severely dehydrated electrodes to normal operation.
- High temperatures, strong acids or caustics will increase electrochemical reactions and speed electrode aging.
- Coatings (e.g. grease) on the glass or junction surfaces cause extended response time and inaccurate measurement.
- Never store the electrode tip in deionized (DI) water. Use pH 4 buffer solution to keep the glass wet when out of the process.
- Never store the electrode at temperatures below 0 °C (32 °F) or allow it to dehydrate.
- Never scrape or sand the glass electrode surface.
- Treat glass electrode surfaces with care to prevent accidental breakage.

### 7.2 Cleaning

Problem	Suggested Solution
Hard Coatings	Use a dilute acid solution (HCl solution of 5% or less). If the electrode has been used in applications with a pH value higher than 7 pH, soak the electrode for 2 to 5 minutes.
	Use a dilute alkaline solution (NaOH solution at 5% or less) if the electrode has been used in applications with pH values less than 7 pH, soak the electrode for 2 to 5 minutes.
	Alternating immersion in acidic and alkaline solutions may be necessary for thorough cleaning.
Soft Coatings	Spray or vigorously stir the electrode with a mild detergent, such as dishwashing liquid. Chlorine bleach can also be used.
Oily or Organic Coatings	Spray or vigorously stir the electrode with a mild detergent or an appropriate solvent that will not attack the materials of construction. (isopropyl alcohol or similar)
ORP Platinum Coating	Gently wipe the electrode surfaces with a paper towel.
After Cleaning	Always rinse the electrode with water after cleaning.
	Soak the electrode in a pH 4 buffer (with KCl if available) for at least 10 minutes after cleaning.

## 8.0 Ordering Information

Mfr. Part No.	Code	Description
3-2724-00	159 001 545	Electrode, pH, flat, PT1000, 3/4 in. NPT
3-2724-01	159 001 546	Electrode, pH, flat, PT1000, ISO 7/1 R3/4
3-2724-10	159 001 547	Electrode, pH, flat, 3K Balco, 3/4 in. NPT
3-2724-11	159 001 548	Electrode, pH, flat, 3K Balco, ISO 7/1 R3/4
3-2726-00	159 001 553	Electrode, pH, bulb, PT1000, 3/4 in. NPT
3-2726-01	159 001 554	Electrode, pH, bulb, PT1000, ISO 7/1 R3/4
3-2726-10	159 001 555	Electrode, pH, bulb, 3K Balco, 3/4 in. NPT
3-2726-11	159 001 556	Electrode, pH, bulb, 3K Balco, ISO 7/1 R3/4
3-2726-HF-00	159 001 549	Electrode, pH, HF resistant, bulb, PT1000, 3/4 in. NPT
3-2726-HF-01	159 001 550	Electrode, pH, HF resistant, bulb, PT1000, ISO 7/1 R3/4
3-2726-HF-10	159 001 551	Electrode, pH, HF resistant, bulb, 3K Balco, 3/4 in. NPT
3-2726-HF-11	159 001 552	Electrode, pH, HF resistant, bulb, 3K Balco, ISO 7/1 R3/4
3-2726-LC-00	159 001 557	Electrode, pH, bulb, Low Cond, PT1000, 3/4 in. NPT
3-2726-LC-01	159 001 558	Electrode, pH, bulb, Low Cond, PT1000, ISO 7/1 R3/4
3-2726-LC-10	159 001 559	Electrode, pH, bulb, Low Cond, 3K Balco, 3/4 in. NPT
3-2726-LC-11	159 001 560	Electrode, pH, bulb, Low Cond, 3K Balco, ISO 7/1 R3/4
3-2725-60	159 001 561	Electrode, ORP, flat, 10 KΩ ID, 3/4 in. NPT
3-2725-61	159 001 562	Electrode, ORP, flat, 10 KΩ ID, ISO 7/1 R3/4

## Accessories and Replacement Parts

Mfr. Part No.	Code	Description
3-2750-1	159 000 744	In-line Sensor Electronics w/Junction Box
3-2750-2	159 000 745	In-line Sensor Electronics w/Junction Box and EasyCal
3-2750-3	159 000 746	Submersible Sensor Electronics with 15 ft cable, 3/4 in. NPT threads
3-2750-4	159 000 842	Submersible Sensor Electronics with 15 ft cable, ISO 7/1 R3/4 threads
3-2760-1	159 000 939	Submersible Preamplifier with 3/4 in. NPT threads and 4.6 m (15 ft) cable
3-2760-2	159 000 940	Submersible Preamplifier with 3/4 in. ISO threads and 4.6 m (15 ft) cable
3-2760-3	159 000 941	Submersible Connector with 4.6 m (15 ft) cable and 3/4 in. NPT threads
3-2760-4	159 000 942	Submersible Connector with 4.6 m (15 ft) cable and ISO 7/1 R3/4 in. threads
3-2760-11	159 001 367	In-line Preamplifier with 3/4 in. NPT threads and 4.6 m (15 ft) cable
3-2760-21	159 001 368	In-line Preamplifier with 3/4 in. ISO threads and 4.6 m (15 ft) cable
3-2760-31	159 001 369	In-line Connector with 4.6 m (15 ft) cable and 3/4 in. NPT threads
3-2760-41	159 001 370	In-line Connector with 4.6 m (15 ft) cable and ISO 7/1 R3/4 threads
3-2759	159 000 762	pH/ORP System Tester (adapter cable sold separately)
3-2759.391	159 000 764	2759 DryLoc Adapter Cable (for use with 2750 and 2760)
3-0700.390	198 864 403	pH Buffer Kit (1 each 4, 7, 10 pH buffer in powder form, makes 50 mL)
3822-7004	159 001 581	pH 4 buffer solution, pint (16 oz) (473 ml)
3822-7007	159 001 582	pH 7 buffer solution, pint (16 oz) (473 ml)
3822-7010	159 001 583	pH 10 buffer solution, pint (16 oz) (473 ml)
3822-7115	159 001 606	20 gram bottle Quinhydrone for ORP calibration
3-2700.395	159 001 605	Calibration kit: included 3 Polypropylene cups, box used as cup stand, 1 pint pH 4.01, 1 pint pH 7.00
3-8050.390-1	159 001 702	Retaining Nut, Replacement, Valox® K4530
3-8050.391	159 001 703	Retaining Nut, Replacement, Stainless Steel



Georg Fischer Signet LLC, 3401 Aerojet Avenue, El Monte, CA 91731-2882 U.S.A. • Tel. (626) 571-2770 • Fax (626) 573-2057  
For Worldwide Sales and Service, visit our website: [www.gfsignet.com](http://www.gfsignet.com) • Or call (in the U.S.): (800) 854-4090  
For the most up-to-date information, please refer to our website at [www.gfsignet.com](http://www.gfsignet.com)